

795010 INSERTABLE HEATING/COOLING JACKET

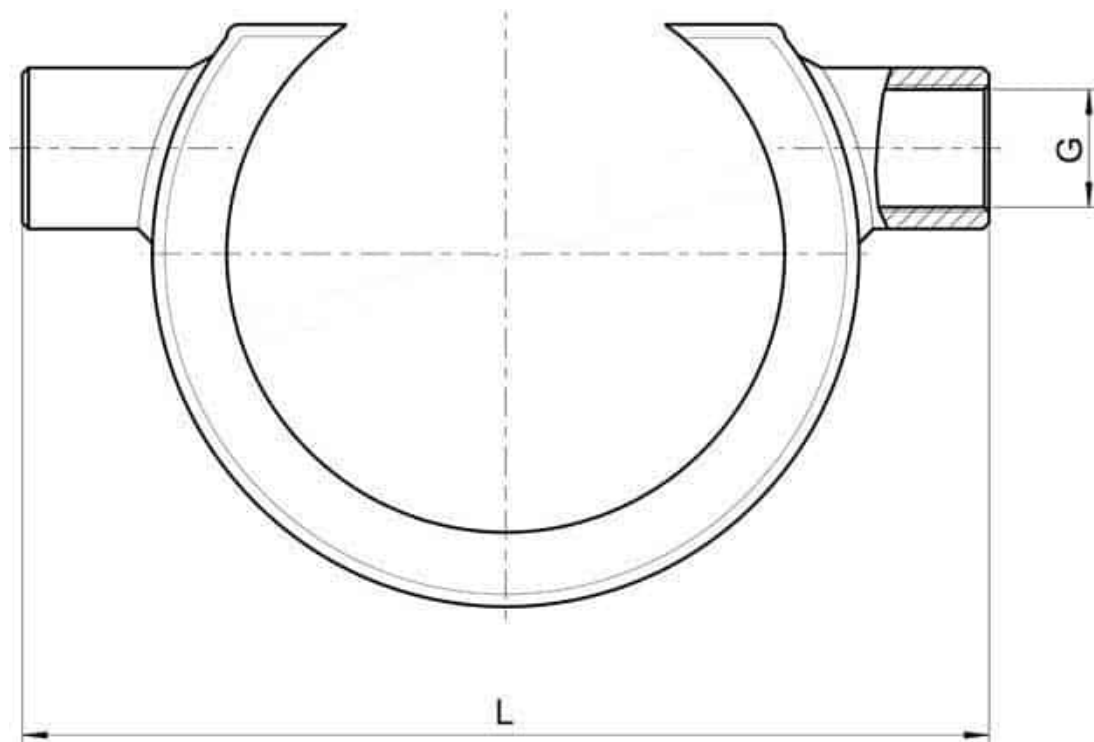

Insertable heating/cooling Jacket
Material: Aisi 304L (1.4307)
Measure: from DN10 to DN100



DN	G (ISO 228)	L	Kg	CODE
10	1/4"	84	0.124	795010 40800
15	1/4"	84	0.130	795010 41400
20	3/8"	100	0.199	795010 42000
25	3/8"	112	0.266	795010 42600
32	3/8"	125	0.349	795010 43000
40	1/2"	150	0.610	795010 43400
50	1/2"	160	0.765	795010 43800
65	1/2"	180	1.230	795010 44500
80	1/2"	204	1.330	795010 44800
100	1/2"	232	1.750	795010 45400

